

The image shows several large rolls of corrugated metal sheet piling, likely made of steel or aluminum, stacked in an outdoor area. The rolls are arranged in a way that shows their curved, ribbed profile. The background consists of dry, yellowish-brown vegetation and a clear sky, suggesting a construction or industrial site in a semi-arid environment. The text 'Rezervuāri Weho' is overlaid in the center of the image in a bold, black, sans-serif font.

# Rezervuāri Weho

Weho konstrukcija ļauj rezervuāru montēt gan virs zemes, gan zemē.

◆ Rezervuāri zem zemes

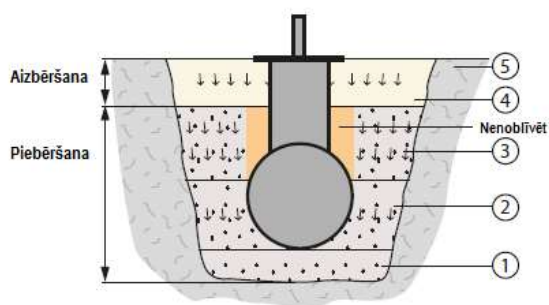

◆ Rezervuārs daļēji virs zemes

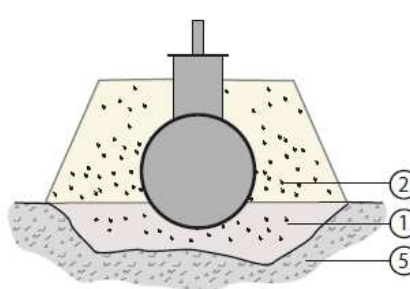

Apraksts:

1. Piebēršana
2. Pamata apbērsana
3. Augšas apbērsana
4. Aizbēršana
5. Virsējais grunts slānis
6. Balsti

◆ Rezervuārs virs zemes

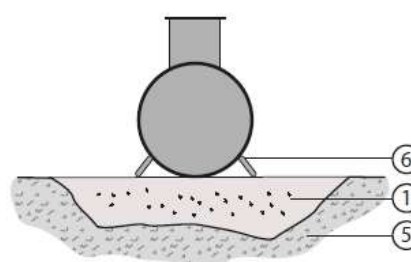
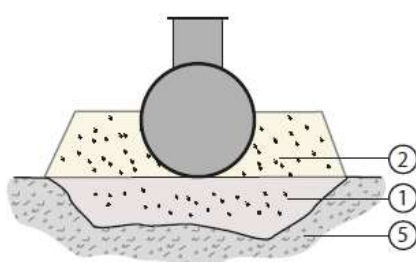

Weho īpašības:

- 100% hermētiski
- Igltpējīgi
- Pilnībā korozijas droši
- Dubults korpuss
- Ķīmiska izturība
- Pilnībā izturīgi pret ultravioleto starojumu
- Salīdzinoši neliels svars
- Viegli montējami arī ziemas apstākļos
- Der vietām ar augstu gruntsūdeni
- Universāls pielietojums
- Izmantojami zem ceļa braucamās daļas

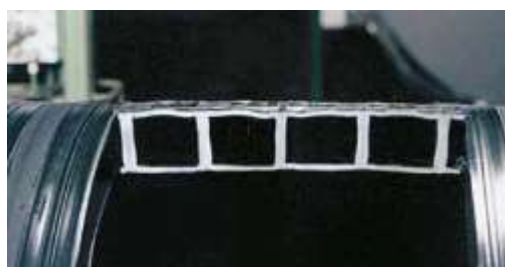

Tālr./ fax 67910874  
[www.asmara.lv](http://www.asmara.lv)  
[asmara@asmara.lv](mailto:asmara@asmara.lv)



## Rezervuāru tilpums

Dw	1000	1200	1400	1600	1800	2000	2200	2400	2600	3000
V=Vn	Lc	Lc	Lc	Lc	Lc	Lc	Lc	Lc	Lc	Lc
m <sup>3</sup>	mm	mm	mm	mm	mm	mm	mm	mm	mm	mm
2	2 560	1 850	-	-	-	-	-	-	-	-
3	3 830	2 740	2 140	-	-	-	-	-	-	-
5	6 370	4 510	3 440	2 700	-	-	-	-	-	-
8	10 190	7 160	5 380	4 190	3 330	-	-	-	-	-
10	12 740	8 930	6 680	5 190	4 120	3 400	-	-	-	-
12	15 290	10 700	7 980	6 180	4 910	4 040	3 500	-	-	-
15	19 110	13 350	9 930	7 670	6 090	4 990	4 290	3 290	-	-
18	22 930	16 000	11 880	9 170	7 260	5 950	5 080	3 950	-	-
20	25 470	17 770	13 180	10 160	8 050	6 580	5 610	4 390	4 110	-
25	31 840	22 190	16 430	12 650	10 010	8 170	6 920	5 500	5 060	-
30	-	26 610	19 680	15 130	11 980	9 770	8 240	6 600	6 000	4 540
35	-	31 030	22 920	17 620	13 940	11 360	9 550	7 710	6 940	5 250
40	-	-	26 170	20 110	15 910	12 950	10 870	8 810	7 880	5 960
45	-	-	29 420	22 590	17 870	14 540	12 180	9 920	8 820	6 670
50	-	-	32 670	25 080	19 840	16 130	13 500	11 020	9 760	7 370
60	-	-	39 160	30 060	23 770	19 320	16 130	13 230	11 650	8 790
70	-	-	45 660	35 030	27 700	22 500	18 760	15 440	13 530	10 200
80	-	-	-	40 000	31 630	25 680	21 390	17 650	15 420	11 620
90	-	-	-	44 980	35 560	28 870	24 020	19 870	17 300	13 030
100	-	-	-	-	39 490	32 050	26 650	22 080	19 180	14 450
110	-	-	-	-	43 420	35 230	29 280	24 290	21 070	15 860
120	-	-	-	-	-	38 410	31 910	26 500	22 950	17 280
130	-	-	-	-	-	41 600	34 540	28 710	24 830	18 690
140	-	-	-	-	-	44 780	37 170	30 920	26 720	20 110
150	-	-	-	-	-	-	39 800	33 130	28 600	21 520
160	-	-	-	-	-	-	42 430	35 340	30 480	22 940
170	-	-	-	-	-	-	45 070	37 550	32 370	24 350
180	-	-	-	-	-	-	-	39 760	34 250	25 770
190	-	-	-	-	-	-	-	41 970	36 130	27 180
200	-	-	-	-	-	-	-	44 180	38 020	28 600
210	-	-	-	-	-	-	-	-	39 900	30 010
220	-	-	-	-	-	-	-	-	41 780	31 420
230	-	-	-	-	-	-	-	-	43 670	32 840
240	-	-	-	-	-	-	-	-	45 550	34 250
250	-	-	-	-	-	-	-	-	-	35 670
260	-	-	-	-	-	-	-	-	-	37 080
270	-	-	-	-	-	-	-	-	-	38 500
290	-	-	-	-	-	-	-	-	-	41 330
300	-	-	-	-	-	-	-	-	-	42 740
310	-	-	-	-	-	-	-	-	-	44 160

Lc - Izmēri ir doti aptuveni, jo reālie izmēri var nedaudz atšķirties

## Rezervuāru korpuss

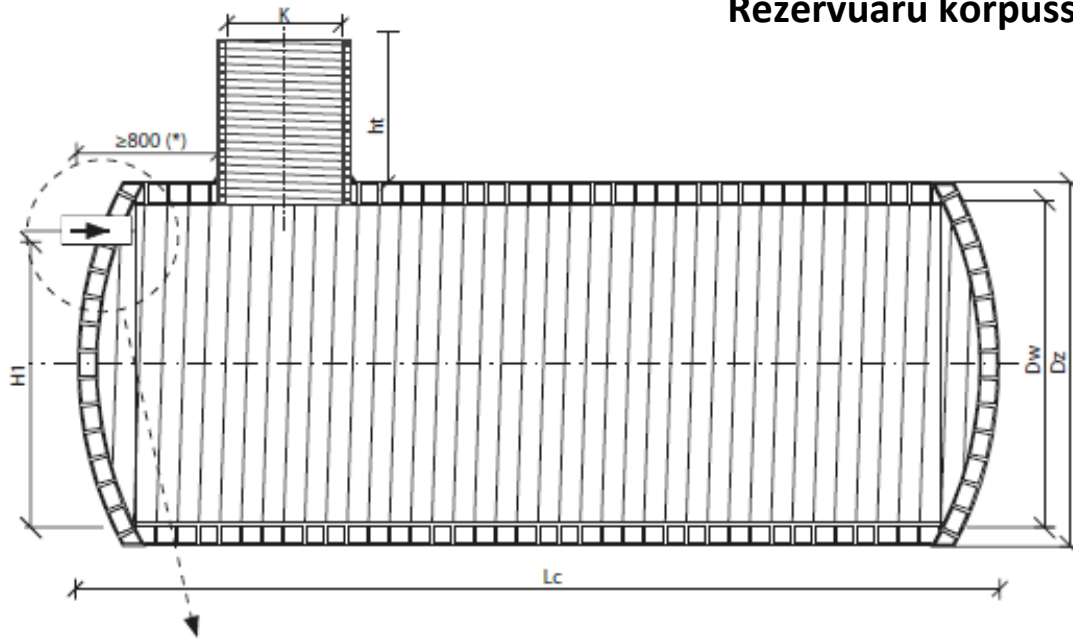

H1, ht, K, 800 – Pēc projekta

Vn – nominalais tilpums

V – kopējais tilpums

## Izplūdes/ izplūdes savienojumi

1. variants

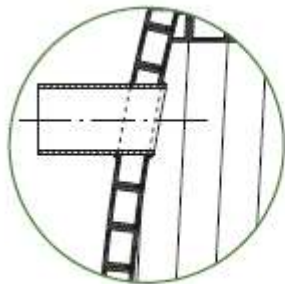

2. variants

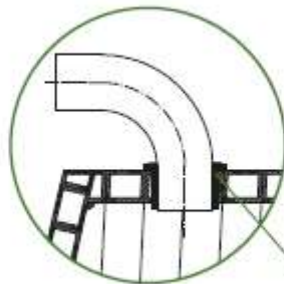

3. variants

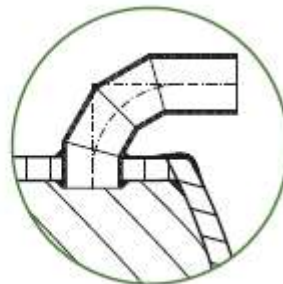

Blīvējums

## Lūkas monzāža

Lūka piestiprināta centrā

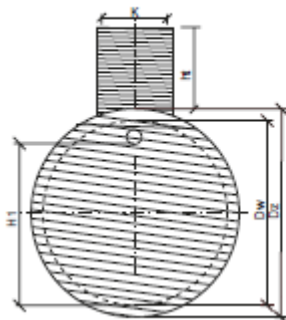

Lūka piestiprināta sānā

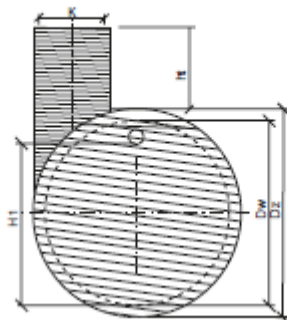

Lūka piestiprināta sānā ar platformu

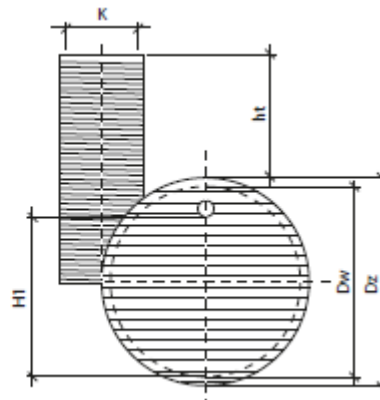

Tālr./ fax 67910874

[www.asmara.lv](http://www.asmara.lv)

[asmara@asmara.lv](mailto:asmara@asmara.lv)

